





Accessoires de Montage pour Accéléromètres

Adaptateurs de Montage Isolés, Montage Goujon

	IMS1	1/2" Hex x 10-32 UNF x 10-32 UNF
	IMS5	5/8" Hex x 10-32 UNF x 10-32 UNF
	IMS9	3/4" Hex x 10-32 UNF x 10-32 UNF
	IMS3	1/2" Hex x 10-32 UNF x 1/4-28
	IMS7	5/8" Hex x 10-32 UNF x 1/4-28
	IMS11	3/4" Hex x 10-32 UNF x 1/4-28

	IMS2	1/2" Hex x 1/4-28 x 10-32 UNF
	IMS6	5/8" Hex x 1/4-28 x 10-32 UNF
	IMS10	3/4" Hex x 1/4-28 x 10-32 UNF
	IMS4	1/2" Hex x 1/4-28 x 1/4-28
	IMS8	5/8" Hex x 1/4-28 x 1/4-28
	IMS12	3/4" Hex x 1/4-28 x 1/4-28

Adaptateurs de Montage Isolés, Montage Adhésif

	IMA1	1/2" Hex x 10-32 UNF
	IMA3	5/8" Hex x 10-32 UNF
	IMA5	3/4" Hex x 10-32 UNF

	IMA2	1/2" Hex x 1/4-28
	IMA4	5/8" Hex x 1/4-28
	IMA6	3/4" Hex x 1/4-28

Adaptateurs de Montage Non-Isolés, Montage Adhésif

	NMA1	1/2" Hex x 10-32 UNF
	NMA3	5/8" Hex x 10-32 UNF
	NMA5	3/4" Hex x 10-32 UNF

	NMA2	1/2" Hex x 1/4-28
	NMA4	5/8" Hex x 1/4-28
	NMA6	3/4" Hex x 1/4-28

Montage Magnétique

	Z301017	Aimant Permanent, Style Pot, Fileté pour écrou #10-32, Ø 13/16" x Haut 3/4"
---	---------	---

	Z302053	Aimant Permanent, Style Pot, Fileté pour écrou #10-32, Ø 1,38" x Haut 1,18"
---	---------	---

Montage Blocs Triaxiaux

	TMB2	Bloc Cube Aluminium 1 Inch avec Trous pour Montage (3) 8-32
	TMB4	Bloc Cube Aluminium 1 Inch avec Trous pour Montage (3) 10-32

	TMB3	Bloc Cube Acier Inox 1-1/4 Inch avec Trous pour Montage (3) 8-32
	TMB5	Bloc Cube Acier Inox 1-1/4 Inch avec Trous pour Montage (3) 10-32

Brides d'Assemblages pour Ø 10 In. ou Petit Cylindre

	CAS1	Isolateur Thermique 1" Hex x 5"L avec Trou de Mtg Accel 1/4-28 & Strap 36"L
	CAS2	Isolateur Thermique 1" Hex x 5"L avec Trou de Mtg Accel 10-32 & Strap 36"L

	CAS3	Adaptateur 1-1/8" Hex x 5/8" H avec Trou de Mtg Accel 1/4-28 & Strap 36"L
	CAS4	Adaptateur 1-1/8" Hex x 5/8" H avec Trou de Mtg Accel 10-32 & Strap 36"L

Câble pour Accéléromètres

Câbles Standards

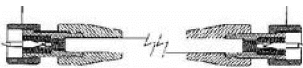
	
LNHT-3 3 Pieds	Câble Coaxial, Câble Ø 0,080" avec Connecteurs #10-32 et #10-32 Capacité Nominale = 30 pf / Pieds
LNHT-6 6 Pieds	
LNHT-10 10 Pieds	
LNHT-xx xx = Pieds	
LNHT-xxM xx = Mètres	

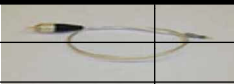
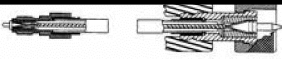
	
MMHR-6 6	Câble Microminiature Faible Bruit, Ø 0,055". Câble avec Connecteurs #2-56 et #10-32
MMHR-12 12 Inches	
MMHR-18 18 Inches	
MMHR-xx xx = Inches	
MMHR-xxC xx = cm	

Adaptateurs pour Câble

	Extension Coupleur Câble LNHT, Réf : Z300492
---	---

	Adaptateur Femelle 10-32 / BNC, Réf: Z300742
--	---

Câbles Spéciaux

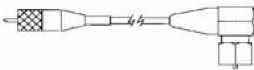
Câble LNHT avec Connecteur à Angle Droit		
LNHT-xx-RA xx = Pieds		
LNHT-xxM-RA xx = Mètres		

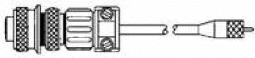
Câble Coaxial #10-32 et MS3106A-10SL-4S		
CID03971-xx xx = Pieds		
CID03971-xxM xx = Mètres		

Câble LNHT #10-32 et Connecteur BNC		
LNHT-xx-BNC xx = Pieds		
LNHT-xxM-BNC xx = Mètres		

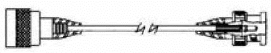
Câble Coaxial TNC et Connecteurs BNC		
CID03046-xx xx = Pieds		
CID03046-xxM xx = Mètres		

Options Câble pour Modèle 951-TX Triaxial

Câble Standard 4-Conduct. avec PC06E-8-4S		
CID03946-xx xx = Pieds		
CID03946-xxM xx = Mètres		

Câble 3-conducteurs, PC06E-8-4S et #10-32		
CID03958xx xx = Pieds		
CID03958xxM xx = Mètres		

Câble Standard 3-Conduct. avec PC06E-8-4S		
CID03959xx xx = Pieds		
CID03959xxM xx = Mètres		

Câble 3-conducteurs, PC06E-8-4S et BNC		
CID03960xx xx = Pieds		
CID03960xxM xx = Mètres		